



Lep IQC 31 x 90 mm

WAND- UND DECKENMONTAGE / 31 X 90 mm / PROFIL 1-LAUF



LEP IQC - gold gebürstet - Seite 164 - Garnitur-Nr. 1-31909-209



LEP IQC - palladium gebürstet - Seite 164 - Garnitur-Nr. 1-31909-850



VERFÜGBARE OBERFLÄCHEN



-29 nickel matt



-157 schwarz matt



-209 gold gebürstet



-850 palladium
gebürstet

Abbildungen im Maßstab 1 : 1

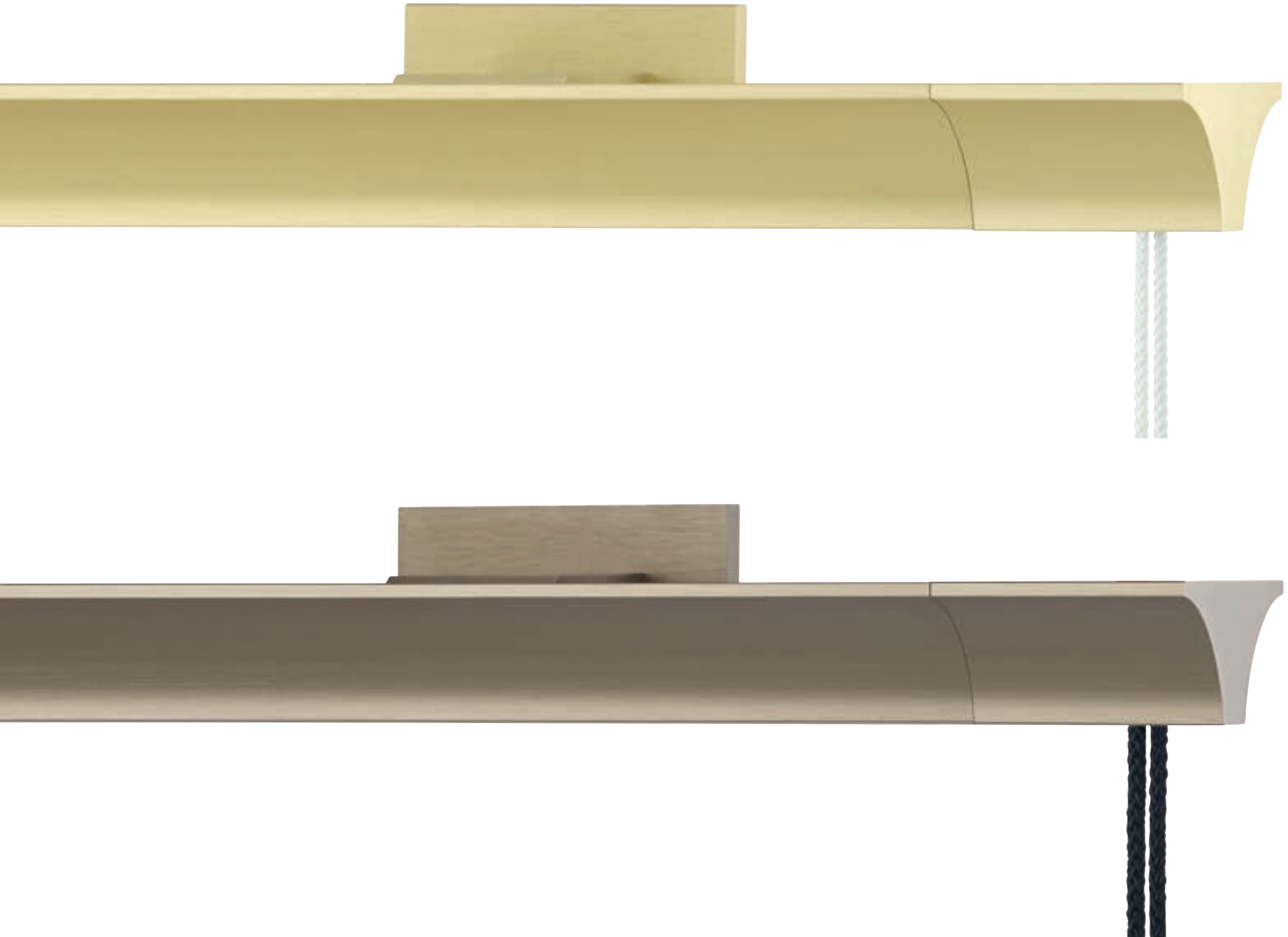

Lep IQC 31 x 90 mm

WAND- UND DECKENMONTAGE / 31 X 90 mm / PROFIL 1-LAUF

BESTELLSCHRITTE

1. System

0-31909-157-200

0-



1-Lauf Profil

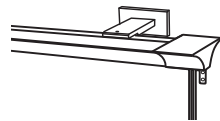

Wandabstand 90 mm

1-



1-Lauf Profil

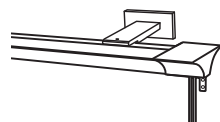

Wandabstand 130 mm

2. Garnitur-Nr.

0-31909-157-200



**SCHNURZUG
GARNITUR LEP**
31909

3. Farbcode

0-31905-29-200

Preisgruppe A



-157
schwarz matt

Preisgruppe B



-29
nickel matt



-209
gold gebürstet



-850
palladium gebürstet

10-



1-Lauf Profil

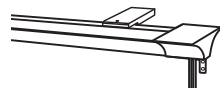

Deckenabstand 32 mm

12-



1-Lauf Profil

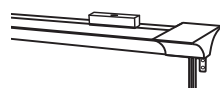

Deckenabstand 46 mm

15-



1-Lauf Profil

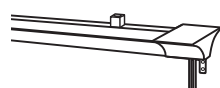

Deckenabstand 46 mm

16-



1-Lauf Profil

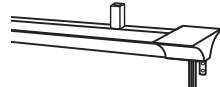

Deckenabstand 66 mm

17-



1-Lauf Profil

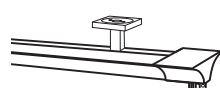

Deckenabstand 74 mm

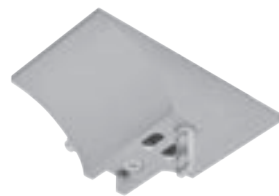

**SCHNURZUG
GARNITUR LEP**
31909

Preisgruppe A



-157
schwarz matt

Preisgruppe B



-29
nickel matt



-209
gold gebürstet



-850
palladium gebürstet

HINWEISE

Nutzen sie bitte die Bestellvorlage auf Seite 171.
Alle Garnituren ohne Schnurzuggewicht.
Schnurzuggewichte siehe Seite 168.

Deckenabstand = Oberkante Deckenträger bis Unterkante Profil
Länge cm = Profillänge inklusive Seilaufnahme und Umlenkung
* Gleiterkette, Endhalter und Stechhaken

WAND- UND DECKENMONTAGE**4. Länge**

0-31909-157-200

Länge cm	Anzahl Träger	Gleiter pro Lauf	0-		1-		Aufpreis* Set Gleiterkette
			1-Lauf Profil A	1-Lauf Profil B	1-Lauf Profil A	1-Lauf Profil B	
100	2	16	437	508	445	516	46
120	2	18	461	534	469	542	46
140	2	20	484	560	492	568	45
160	2	24	509	586	517	594	44
180	2	26	532	612	540	620	44
200	2	28	556	639	564	647	43
220	3	32	655	760	667	772	54
240	3	34	679	786	691	798	54
260	3	36	703	812	715	824	53
280	3	40	727	839	739	851	52
300	3	42	750	865	762	877	52
320	3	44	774	891	786	903	67
340	3	46	798	917	810	929	67
360	3	48	822	943	834	955	66
380	3	52	846	970	858	982	65
400	3	54	869	996	881	1008	65
420	3	56	893	1022	905	1034	80
440	4	60	992	1144	1008	1160	79
460	4	62	1016	1170	1032	1186	79
480	4	64	1040	1196	1056	1212	78
500	4	68	1064	1223	1080	1239	77
520	4	72	1088	1249	1104	1265	88
540	4	74	1112	1275	1128	1291	88
560	4	76	1136	1301	1152	1317	87
580	4	80	1160	1328	1176	1344	86

Länge cm	Anzahl Träger	Gleiter pro Lauf	10-		12-		15-		16-		17-		Aufpreis* Set Gleiterkette
			1-Lauf Profil A	1-Lauf Profil B	1-Lauf Profil A	1-Lauf Profil B	1-Lauf Profil A	1-Lauf Profil B	1-Lauf Profil A	1-Lauf Profil B			
100	2	16	359	398	359	398	341	380	347	386	373	432	46
120	2	18	383	424	383	424	365	406	371	412	397	458	46
140	2	20	406	450	406	450	388	432	394	438	420	484	45
160	2	24	431	476	431	476	413	458	419	464	445	510	44
180	2	26	454	502	454	502	436	484	442	490	468	536	44
200	2	28	478	529	478	529	460	511	466	517	492	563	43
220	3	32	538	595	538	595	511	568	520	577	559	646	54
240	3	34	562	621	562	621	535	594	544	603	583	672	54
260	3	36	586	647	586	647	559	620	568	629	607	698	53
280	3	40	610	674	610	674	583	647	592	656	631	725	52
300	3	42	633	700	633	700	606	673	615	682	654	751	52
320	3	44	657	726	657	726	630	699	639	708	678	777	67
340	3	46	681	752	681	752	654	725	663	734	702	803	67
360	3	48	705	778	705	778	678	751	687	760	726	829	66
380	3	52	729	805	729	805	702	778	711	787	750	856	65
400	3	54	752	831	752	831	725	804	734	813	773	882	65
420	3	56	776	857	776	857	749	830	758	839	797	908	80
440	4	60	836	924	836	924	800	888	812	900	864	992	79
460	4	62	860	950	860	950	824	914	836	926	888	1018	79
480	4	64	884	976	884	976	848	940	860	952	912	1044	78
500	4	68	908	1003	908	1003	872	967	884	979	936	1071	77
520	4	72	932	1029	932	1029	896	993	908	1005	960	1097	88
540	4	74	956	1055	956	1055	920	1019	932	1031	984	1123	88
560	4	76	980	1081	980	1081	944	1045	956	1057	1008	1149	87
580	4	80	1004	1108	1004	1108	968	1072	980	1084	1032	1176	86

Wellenband und Gleiterkette ab Seite 24

Bestellangaben: System, Garnitur-Nr., Farbcode, Länge - Unverbindlich empfohlene Verkaufspreise in EURO inkl. MwSt.

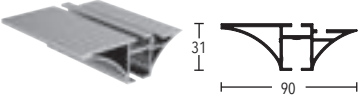
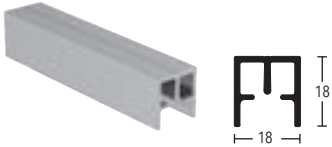
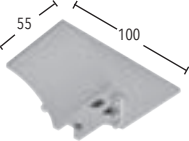
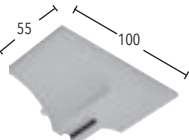
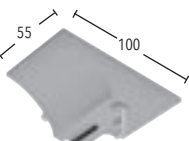
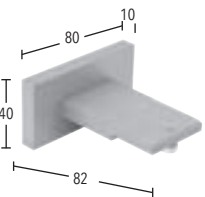
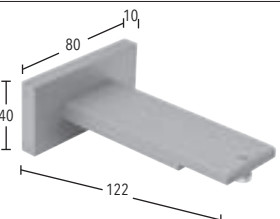
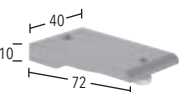

Lep IQC 31 x 90 mm Einzelteile

	ARTIKEL	OBERFLÄCHE	ARTIKEL-NR.	EURO / STCK.			
	ALUMINIUM-PROFIL LEP 31 x 90 mm Preis € per Meter Lagerlänge 6 m	nickel matt	8223190-29	Zuschnitt	114,00	Lagerlänge	95,00
		schwarz matt	-157	€/m	102,00	€/m	85,00
		gold gebürstet	-209		114,00		95,00
		palladium gebürstet	-850		114,00		95,00
	ALUMINIUM-EINSCHUB-PROFIL erforderlich für Schnurzugarnituren Preis € per Meter Lagerlänge 6 m Hinweis: zwingend erforderlich für jedes System	silber	8221818-108	Zuschnitt	12,00	Lagerlänge	10,00
		schwarz	-157	€/m	12,00	€/m	10,00
	SEILAUFNAHME LEP MIT ÖSE für Profil Art.-Nr. 8223190 VE = 1 Stück	nickel matt	11687-90-29				95,00
		schwarz matt	-157				85,00
	UMLENKUNG LEP zur Umlenkung des Seils für Profil Art.-Nr. 8223190 VE = 1 Stück	gold gebürstet	-209				95,00
		palladium gebürstet	-850				95,00
		nickel matt	11686-90-29				90,00
		schwarz matt	-157				80,00
	UMLENKUNG LEP MIT ÖSE zur Umlenkung des Seils für Profil Art.-Nr. 8223190 VE = 1 Stück	gold gebürstet	-209				90,00
		palladium gebürstet	-850				90,00
		nickel matt	11686-90-E-29				90,00
		schwarz matt	-157				80,00
	WANDTRÄGER LEP (System 0-) 1-läufig, Wandabstand 90 mm für Profil Art.-Nr. 8223190 VE = 6 Stück	gold gebürstet	-209				95,00
		palladium gebürstet	-850				95,00
		nickel matt	11220-90-29				95,00
		schwarz matt	-157				75,00
	WANDTRÄGER LEP (System 1-) 1-läufig, Wandabstand 130 mm für Profil Art.-Nr. 8223190 VE = 6 Stück	gold gebürstet	-209				99,00
		palladium gebürstet	-850				99,00
		nickel matt	11220-130-29				99,00
		schwarz matt	-157				79,00
	DECKENTRÄGER LEP 5 mm (System 10-) 1-läufig, Deckenabstand 32 mm für Profil Art.-Nr. 8223190 VE = 10 Stück	gold gebürstet	-209				40,00
		palladium gebürstet	-850				40,00
		nickel matt	11220-20-29				40,00
		schwarz matt	-157				36,00

Lep IQC 31 x 90 mm Einzelteile

	ARTIKEL	OBERFLÄCHE	ARTIKEL-NR.	EURO / STCK.
	DECKENTRÄGER 15 mm (System 12-) 1-läufig, Deckenabstand 46 mm für Profile VE = 10 Stück	nickel matt schwarz matt gold gebürstet palladium gebürstet	11473-100-29 -157 -209 -850	40,00 36,00 40,00 40,00
	DECKENTRÄGER 15 mm (System 15-) 1-läufig, Deckenabstand 46 mm für Profile VE = 10 Stück	nickel matt schwarz matt gold gebürstet palladium gebürstet	11473-15-29 -157 -209 -850	31,00 27,00 31,00 31,00
	DECKENTRÄGER 35 mm (System 16-) 1-läufig, Deckenabstand 66 mm für Profile VE = 10 Stück	nickel matt schwarz matt gold gebürstet palladium gebürstet	11473-35-29 -157 -209 -850	34,00 30,00 34,00 34,00
	DECKENTRÄGER 43 mm (System 17-) 1-läufig, Deckenabstand 74 mm für Profile VE = 6 Stück	nickel matt schwarz matt gold gebürstet palladium gebürstet	11473-50-29 -157 -209 -850	57,00 43,00 57,00 57,00
	DECKENTRÄGER 73 mm 1-läufig, Deckenabstand 104 mm für Profile VE = 6 Stück	nickel matt schwarz matt gold gebürstet palladium gebürstet	11473-80-29 -157 -209 -850	62,00 49,00 62,00 62,00
	TRÄGERVERLÄNGERUNG (eckig) Länge 35 mm für alle Träger Art.-Nr. 11473-35, 11473-50 und 11473-80 VE = 10 Stück	nickel matt schwarz matt gold gebürstet palladium gebürstet	11473-2/2-29 -157 -209 -850	28,00 23,00 28,00 28,00
	SEIL FÜR SCHNURZUGSYSTEM Rolle 250 Meter Preis € per Meter	weiß grau schwarz	8809-20-00 -08 -57	1,00 1,00 1,00
	SEILVERBINDER VE = 1 Stück	weiß grau schwarz	8809-41-00 -08 -57	3,00 3,00 3,00

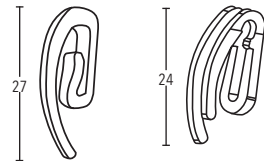
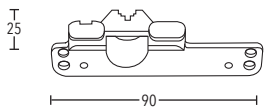
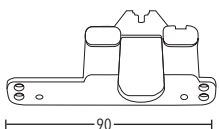
Lep IQC 31 x 90 mm Einzelteile

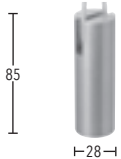
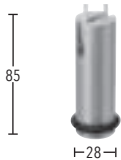
	ARTIKEL	OBERFLÄCHE	ARTIKEL-NR.	EURO / STCK.
	GLEITER	weiß	8809-52-00	0,25
	VE = 100 Stück	grau schwarz	-08 -57	0,25 0,25
	STECCHAKEN DOPPEL-STECCHAKEN	natur	869-00	0,10
	VE=100 Stück	natur	853-00	0,20
	MITNEHMER ALS UNTERLAUF	weiß	8809-23-00	3,00
	VE = 1 Stück	grau schwarz	-08 -57	3,00 3,00
	MITNEHMER ALS ÜBERLAUF	weiß	8809-24-00	3,00
	VE = 1 Stück	grau schwarz	-08 -57	3,00 3,00
	WAVE-MITNEHMER	weiß	8809-34-00	3,00
	VE = 1 Stück	grau schwarz	-08 -57	3,00 3,00
	SCHNURZUGGEWICHT ZYLINDER	nickel matt	11688-29	35,00
	Gewicht ca. 140 g VE = 1 Stück	schwarz matt gold gebürstet palladium gebürstet	-157 -209 -850	32,00 35,00 35,00
	SCHNURZUGGEWICHT ZYLINDER	nickel matt	11689-29	38,00
	mit Gummiring Gewicht ca. 150 g VE = 1 Stück	schwarz matt gold gebürstet palladium gebürstet	-157 -209 -850	35,00 38,00 38,00

Ausklinkungen, Biegungen, Gehrungsschnitte,
Gleiterhöhen, Wellenbandtechnik und Kindersicherheit siehe Seite 24 - 29
Trägersonderlängen auf Anfrage
Weiteres Zubehör siehe Inside Katalog ab Seite 204 / Vion Katalog ab Seite 142

Lep IQC 31 x 90 mm Illustrationen



Wandträger
Art.-Nr. 11220-90

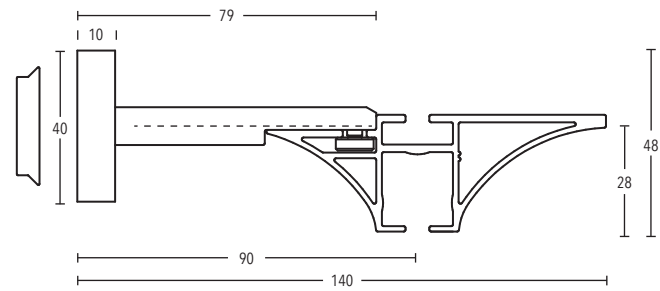

Wandträger
Art.-Nr. 11220-130

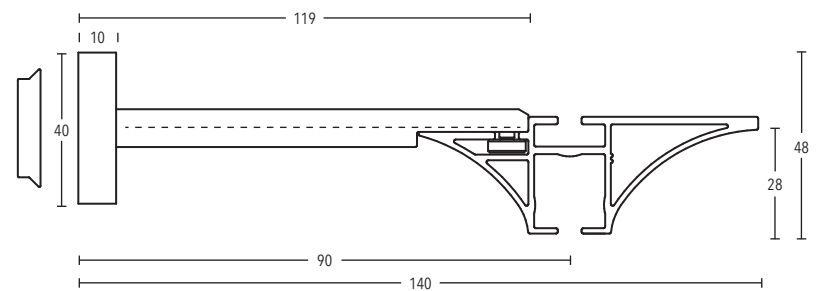

Deckenträger 5 mm
Art.-Nr. 11220-20

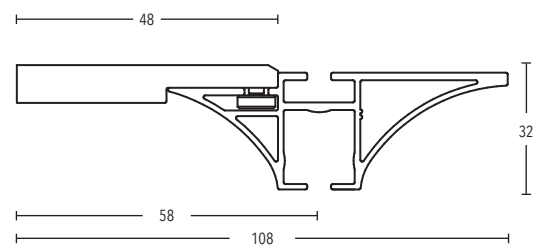

Deckenträger 15 mm
Art.-Nr. 11473-100

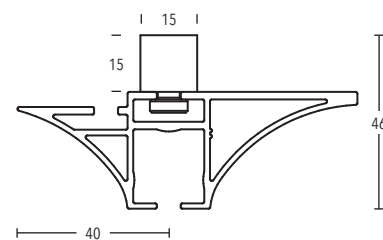

Lep IQC 31 x 90 mm Illustrationen



Deckenträger 15 mm + 35 mm
Art.-Nr. 11473-15 + 11473-35

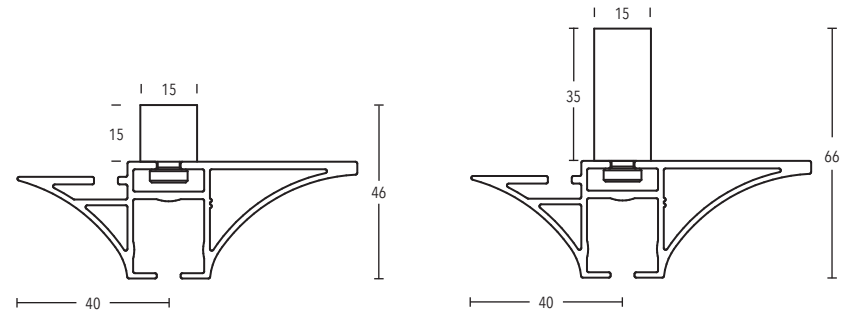

Deckenträger 43 mm + 73 mm
Art.-Nr. 11473-50 + 11473-80

